

SBB TECH

Mechanical Power Transmission System

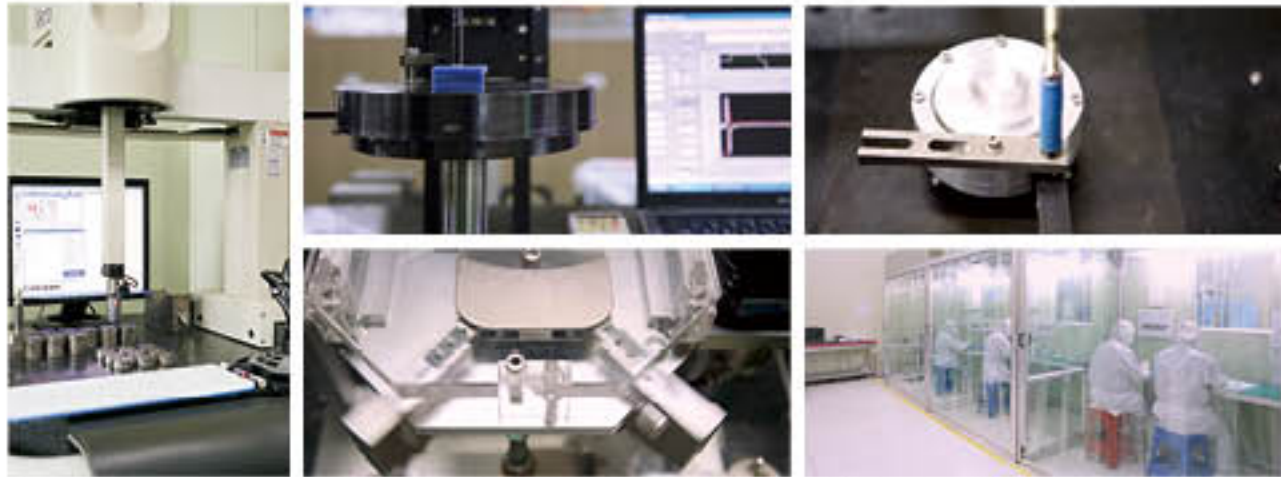

Clean Room & Measuring Equipment



Three dimension coordinate measuring machine

▲ Bearing torque testing equipment
▼ Wrist durability testing equipment

▲ Bearing torque testing equipment
▼ Bearing assembly



ROBO Bearings



Robot repair

HP Robot(Hybrid Ceramic Bearing)

DESCRIPTION	Q'ty/Set	SBB P/N	PRODUCT	REMARK
HP/HP+ HUB CERAMIC BEARING	4	S2N-X060PTS-3N4G 4S-X060PTS-3N4G		INNER/OUTER : SUJ2+NI COATING or SUS440C RETAINER : PCTFE BALL : S3N4G COVER : SUS SNAP RING TYPE : 4 POINT BAKING & Grease Annealing(OUT GAS REMOVE) CLEAN ROOM ASSEMBLY & VACUUM PACKING HIGH VACUUM DYNAMIC GREASE(10* Torr) RETROFIT TEST CONFIRM OF SAMSUNG/SK HYNIX
HP/HP+ PIVOT BEARING	4	4S-A010-3N4-3N4G		INNER/OUTER : SUS440C RETAINER : S3N4 BALL : S3N4G COVER : None TYPE : ANGULAR BAKING & Grease Annealing(OUT GAS REMOVE) CLEAN ROOM ASSEMBLY & VACUUM PACKING HIGH VACUUM DYNAMIC GREASE(10* Torr) RETROFIT TEST CONFIRM OF SAMSUNG/SK HYNIX
HP ARM BEARING	4	4S-F5S3.PZZ-3N4G		INNER/OUTER : SUS440C RETAINER : STAINLESS STEEL BALL : S3N4G COVER : PEEK TYPE : 2 POINT BAKING & Grease Annealing(OUT GAS REMOVE) CLEAN ROOM ASSEMBLY & VACUUM PACKING HIGH VACUUM DYNAMIC GREASE(10* Torr) RETROFIT TEST CONFIRM OF SAMSUNG/SK HYNIX

HP+ Robot Bearing Set

DESCRIPTION	Q'ty/Set	SBB P/N	PRODUCT	REMARK
HP/HP+ HUB CERAMIC BEARING	4	S2N-X060PTS-3N4G 4S-X060PTS-3N4G		INNER/OUTER : SUJ2+NI COATING or SUS440C RETAINER : PCTFE BALL : S3N4G COVER : SUS SNAP RING TYPE : 4 POINT BAKING & Grease Annealing(OUT GAS REMOVE) CLEAN ROOM ASSEMBLY & VACUUM PACKING HIGH VACUUM DYNAMIC GREASE(10* Torr) RETROFIT TEST CONFIRM OF SAMSUNG/SK HYNIX
ASSY LEFT/RIGHT HAND PIVOT BEARING	1	SBB3S8T4TA10LR,RR		* BEARING * INNER/OUTER : SUS440C RETAINER : S3N4 BALL : S3N4G COVER : None TYPE : ANGULAR * PIVOT * PIVOT : SUS420J2 GEAR : 0.05mm WIRE CUT
HP+/VHP/VHP+ ARM UPPER BEARING	2	4S-R6PKN-3N4G		INNER/OUTER : SUS440C RETAINER : PEEK BALL : S3N4G COVER : None TYPE : 2 POINT BAKING & Grease Annealing(OUT GAS REMOVE) CLEAN ROOM ASSEMBLY & VACUUM PACKING HIGH VACUUM DYNAMIC GREASE(10* Torr) RETROFIT TEST CONFIRM OF SAMSUNG/SK HYNIX
HP+/VHP/VHP+ ARM LOWER BEARING	2	4S-F4PKN-3N4G		INNER/OUTER : SUS440C RETAINER : PEEK BALL : S3N4G COVER : PEEK TYPE : 2 POINT BAKING & Grease Annealing(OUT GAS REMOVE) CLEAN ROOM ASSEMBLY & VACUUM PACKING HIGH VACUUM DYNAMIC GREASE(10* Torr) RETROFIT TEST CONFIRM OF SAMSUNG/SK HYNIX



VHP/VHP+ Robot Bearing



DESCRIPTION	Q'ty/Set	SBB P/N	PRODUCT	REMARK
VHP/VHP+ HUB CERAMIC BEARING	2	S2N-X080PTS-3N4G 45-X080PTS-3N4G		INNER/OUTER : SUJ2+Ni COATING or SUJ440C RETAINER : PCTFE BALL : SBN4G COVER : SUS SNAPRING TYPE : 4 POINT BAKING & Grease Annealing(OUT GAS REMOVE) CLEAN ROOM ASSEMBLY & VACUUM PACKING HIGH VACUUM DYNAMIC GREASE(10 ⁻⁸ Torr) RETROFIT TEST CONFIRM OF SAMSUNG/SK HYNIX
ASS'Y LEFT/RIGHT HAND PIVOT BEARING	2	SBB358T4TA10LR/RR		* BEARING * INNER/OUTER : SUS440C RETAINER : SBN4 BALL : SBN4G COVER : None TYPE : ANGULAR * PIVOT * PIVOT : SUS420J2 GEAR : 0.05 mm WIRE CUT
HP+/VHP/VHP+ ARM UPPER BEARING	4	45-R6PKN-3N4G		INNER/OUTER : SUS440C RETAINER : PEK BALL : SBN4G COVER : None TYPE : 2 POINT BAKING & Grease Annealing(OUT GAS REMOVE) CLEAN ROOM ASSEMBLY & VACUUM PACKING HIGH VACUUM DYNAMIC GREASE(10 ⁻⁸ Torr) RETROFIT TEST CONFIRM OF SAMSUNG/SK HYNIX
HP+/VHP/VHP+ ARM LOWER BEARING	4	45-F4PKN-3N4G		INNER/OUTER : SUS440C RETAINER : PEK BALL : SBN4G COVER : PEK TYPE : 2 POINT BAKING & Grease Annealing(OUT GAS REMOVE) CLEAN ROOM ASSEMBLY & VACUUM PACKING HIGH VACUUM DYNAMIC GREASE(10 ⁻⁸ Torr) RETROFIT TEST CONFIRM OF SAMSUNG/SK HYNIX

Assembly Buffer Wrist

DESCRIPTION	SBB P/N	PRODUCT	REMARK
HP+/VHP+ WRIST ASSY (GEAR TYPE)	SBBCAR0		PARTICLE REDUCTION WAFER SCRATCH PROBLEM SOLUTION LONG LIFETIME BEARING <APPLICATION> CENTURA/DPS BUFFER ROBOT
HP/VHP WRIST ASSY (GEAR TYPE)	SBBCAR1		PARTICLE REDUCTION WAFER SCRATCH PROBLEM SOLUTION LONG LIFETIME BEARING <APPLICATION> ENDURA 550/CENTURA BUFFER ROBOT (NOT EXTENDED RVOT TYPE)
HP/HP+/VHP/VHP+ WRIST ASSY (BELT TYPE)	SBBCAR2		PARTICLE REDUCTION WAFER SCRATCH PROBLEM SOLUTION LONG LIFETIME BEARING <APPLICATION> CENTURA/DPS BUFFER ROBOT ENDURA 550/CENTURA BUFFER ROBOT



Buffer DB Type Wrist







Transfer Type Wrist

Assembly Transfer Wrist

DESCRIPTION	SBB P/N	PRODUCT	REMARK
HP+/VHP+ WRIST ASSY (GEAR TYPE)	SBBTWAR0		PARTICLE REDUCTION WAFER SCRATCH PROBLEM SOLUTION LONG LIFETIME BEARING <APPLICATION> CENTURA/DPS TRANSFER ROBOT
HP+/VHP+ WRIST ASSY (GEAR TYPE)	SBBTWAR1		PARTICLE REDUCTION WAFER SCRATCH PROBLEM SOLUTION LONG LIFETIME BEARING <APPLICATION> ENDURA 550/CENTURA TRANSFER ROBOT (NOT EXTENDED PM OF TYPE)
HP/HP+/VHP/VHP+ WRIST ASSY (BELT TYPE)	SBBTWAR3		PARTICLE REDUCTION WAFER SCRATCH PROBLEM SOLUTION LONG LIFETIME BEARING <APPLICATION> CENTURA/DPS TRANSFER ROBOT ENDURA 550/CENTURA TRANSFER ROBOT

WRIST(CXZ, HDP ULTIMA)

DESCRIPTION	SBB P/N	PRODUCT	REMARK
HP+/VHP+ WRIST ASSY (GEAR TYPE)	SBBHTFWAR1		PARTICLE REDUCTION WAFER SCRATCH PROBLEM SOLUTION LONG LIFETIME BEARING <APPLICATION> HP ROBOT HTF WRIST ASSY of CVD AREA
HP/VHP WRIST ASSY (BELT TYPE)	SBBHTFWAR2		PARTICLE REDUCTION WAFER SCRATCH PROBLEM SOLUTION LONG LIFETIME BEARING <APPLICATION> HP ROBOT HTF WRIST ASSY of CVD AREA
EXTENDED PIVOT ASSY (GEAR TYPE)	SBBEWAR1		PARTICLE REDUCTION WAFER SCRATCH PROBLEM SOLUTION LONG LIFETIME BEARING <APPLICATION> ULTIMA HDP BUFFER ROBOT (EXTENDED PW OF TYPE)
EXTENDED PIVOT ASSY (BELT TYPE)	SBBEWAR2		PARTICLE REDUCTION WAFER SCRATCH PROBLEM SOLUTION LONG LIFETIME BEARING <APPLICATION> ULTIMA HDP BUFFER ROBOT (EXTENDED PW OF TYPE)

12 INCH WRIST ASSEMBLY

DESCRIPTION	SBB P/N	PRODUCT	REMARK
12 INCH BELT TYPE WRIST ASSY	SBB12WAB-TI-LCF		PARTICLE REDUCTION WAFER SCRATCH PROBLEM SOLUTION LONG LIFETIME BEARING <APPLICATION> PVD ENDURA2 XPETCH ULTIMA VHP
	SBB12WAB-TI-LCF (SENSOR BAR)		PARTICLE REDUCTION WAFER SCRATCH PROBLEM SOLUTION LONG LIFETIME BEARING <APPLICATION> CVD ULTIMA VHP/ETCH DPS POLY METAL/E-MAX VHP
12 INCH GEAR TYPE WRIST REPAIR	SBB12WAA-AL-R		PARTICLE REDUCTION WAFER SCRATCH PROBLEM SOLUTION LONG LIFETIME BEARING
	SBB12WAA-AL-R (SENSOR BAR)		<APPLICATION> XPVHP/VHP ROBOT

8" WRIST ASSEMBLY DRAWING

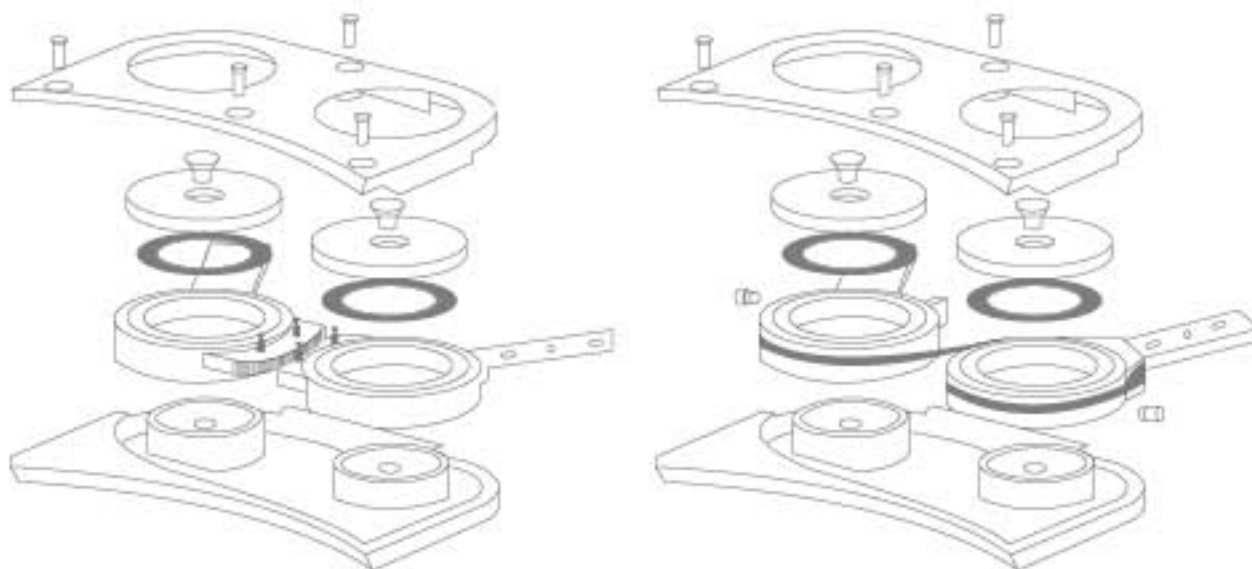

SBB12WAB-TI-LCF

PRODUCER Robot Bearing



DESCRIPTION	Qty/Set	SBB P/N	PRODUCT	REMARK
PRODUCER HUB BEARING	2	52N-X080PTS-3N4G 45-X080PTS-3N4G		INNER/OUTER : SUJ2+Ni COATING or SU5440C RETAINER : PCTFE BALL : SBN4G COVER : SUS SNAPPING TYPE : 4 POINT BAKING & Grease Annealing(OUT GAS REMOVE) CLEAN ROOM ASSEMBLY & VACUUM PACKING HIGH VACUUM DYNAMIC GREASE(10 ⁻⁶ Torr) RETROFIT TEST CONFIRM OF SAMSUNG/SK HYNIX
PRODUCER WRIST LARGE BEARING	4	45-A020-3N4-3N4G		INNER/OUTER : SUS440C RETAINER : SBN4 BALL : SBN4G COVER : None TYPE : ANGULAR BAKING & Grease Annealing(OUT GAS REMOVE) CLEAN ROOM ASSEMBLY & VACUUM PACKING HIGH VACUUM DYNAMIC GREASE(10 ⁻⁶ Torr) RETROFIT TEST CONFIRM OF SAMSUNG/SK HYNIX
PRODUCER WRIST SMALL BEARING	4	45-A7805-3N4-3N4G		INNER/OUTER : SUS440C RETAINER : SBN4 BALL : SBN4G COVER : None TYPE : ANGULAR BAKING & Grease Annealing(OUT GAS REMOVE) CLEAN ROOM ASSEMBLY & VACUUM PACKING HIGH VACUUM DYNAMIC GREASE(10 ⁻⁶ Torr) RETROFIT TEST CONFIRM OF SAMSUNG/SK HYNIX

ENDURA2 XP Robot Bearing



BROOKS Robot Bearing

DESCRIPTION	Qty/Set	SBB P/N	PRODUCT	REMARK
HUB HYBRID BEARING	2/4/6	45-A025T/E-3N4G		INNER/OUTER : SU5440C RETAINER : TEFRON BALL : SBN4G COVER : None TYPE : ANGULAR BAKING & Grease Annealing(OUT GAS REMOVE) CLEAN ROOM ASSEMBLY & VACUUM PACKING HIGH VACUUM DYNAMIC GREASE(10 ⁻⁶ Torr) RETROFIT TEST CONFIRM OF SAMSUNG/SK HYNIX
WRIST HYBRID BEARING	4	45-X010T/E-3N4G		INNER/OUTER : SU5440C RETAINER : TEFRON BALL : SBN4G COVER : None TYPE : 4 POINT BAKING & Grease Annealing(OUT GAS REMOVE) CLEAN ROOM ASSEMBLY & VACUUM PACKING HIGH VACUUM DYNAMIC GREASE(10 ⁻⁶ Torr) RETROFIT TEST CONFIRM OF SAMSUNG/SK HYNIX
ARM HYBRID BEARING	8	45-AB538-3N4-3NG		INNER/OUTER : SU5440C RETAINER : SBN4 BALL : SBN4G COVER : None TYPE : ANGULAR BAKING & Grease Annealing(OUT GAS REMOVE) CLEAN ROOM ASSEMBLY & VACUUM PACKING HIGH VACUUM DYNAMIC GREASE(10 ⁻⁶ Torr) RETROFIT TEST CONFIRM OF SAMSUNG/SK HYNIX

DESCRIPTION	Qty/Set	SBB P/N	PRODUCT	REMARK
XP/VXP HUB CERAMIC BEARING	4	45-DA090-3N4-3N4G		INNER/OUTER : SUS440C RETAINER : SBN4 BALL : SBN4G COVER : None TYPE : DUAL ANGULAR BAKING & Grease Annealing(OUT GAS REMOVE) CLEAN ROOM ASSEMBLY & VACUUM PACKING HIGH VACUUM DYNAMIC GREASE(10 ⁻⁶ Torr) RETROFIT TEST CONFIRM OF SAMSUNG/SK HYNIX
XP ELBOW BEARING	4	45-D5203PKZ-3N4		INNER/OUTER : SUS440C RETAINER : PEEK BALL : SBN4 COVER : PEEK TYPE : DUAL 2 POINT BAKING & Grease Annealing(OUT GAS REMOVE) CLEAN ROOM ASSEMBLY & VACUUM PACKING HIGH VACUUM DYNAMIC GREASE(10 ⁻⁶ Torr) RETROFIT TEST CONFIRM OF SAMSUNG/SK HYNIX
XP/VXP INNER MAGNET BEARING	3	45-X042PTS-3N4G		INNER/OUTER : SUS440C RETAINER : SBN4 BALL : SBN4G COVER : SUS SNAPPING TYPE : 4 POINT BAKING & Grease Annealing(OUT GAS REMOVE) CLEAN ROOM ASSEMBLY & VACUUM PACKING HIGH VACUUM DYNAMIC GREASE(10 ⁻⁶ Torr) RETROFIT TEST CONFIRM OF SAMSUNG/SK HYNIX

LK CRESCENT ASS'Y



* Made in SBB Retrofit

IDLER MEGASONIC



* Made in SBB Retrofit

MAGNET ROLLER



PUSHER DRIVE MAGNET



PICKING CYLINDER



IDLER DRIVE CENTER



EBARA BLUSH BLOCK



MOTOR REPAIR



ROBOT TEST

1. Bearing Torque Test

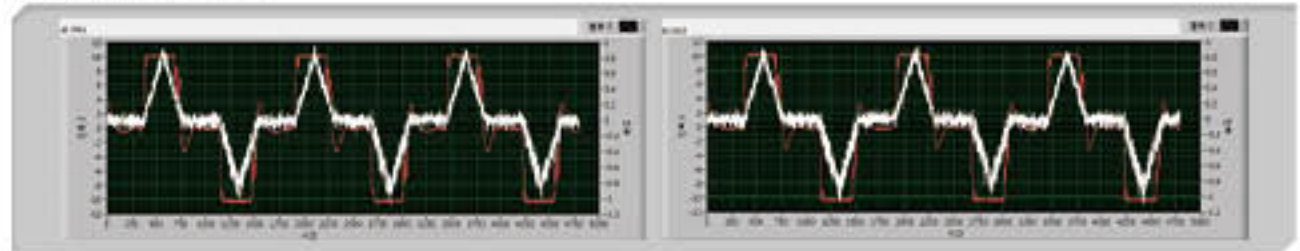

2. Robot Position Repeatability Cycle Test

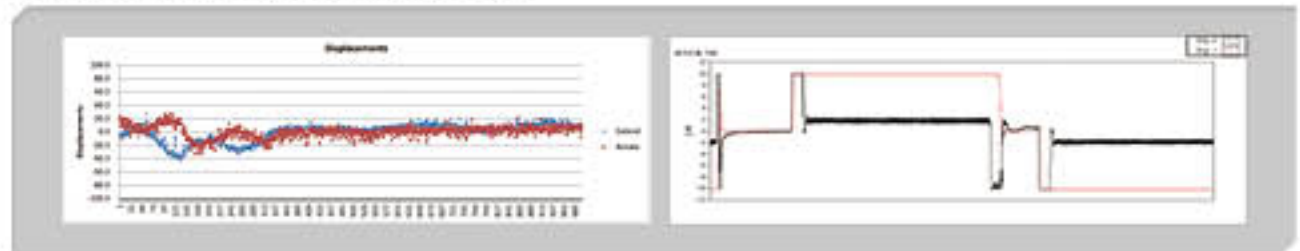

Robot Reproducibility Test

Bearing Load Currenttest

3. Motor Phase Test





SBB

BALL & BEARING

Sales Headquarter B-304 Digital Empire Bldg, 16, Deogyong-daero 1556 beon-gil, Yeongtong-gu, Suwon-si, Gyeonggi-do, 16690, Korea
Head Office 22, Gimpo-daero 2918 beon-gil, Wolgot-myeon, Gimpo-si, Gyeonggi-do, 10048, Korea
Tel. +82-31-988-4085 Fax. +82-31-988-4083 www.sbb.co.kr